

AECOM

locality
the power of community

DESIGN GUIDANCE & CODES

LAWSHALL

FINAL REPORT | SEPTEMBER 2021



Quality information

Prepared by	Checked by	Approved by
Holly Turner	Ben Castell	Ben Castell
Graduate Urban Designer	Technical Director	Director

Revision History

Revision	Revision date	Details	Name	Position
Rv.00	30.06.2021	Preparation of the report	Holly Turner	Graduate Urban Designer
Rv.01	16.08.2021	Comments from group	David Page	Lawshall Neighbourhood Plan Steering Group

This document has been prepared by AECOM Limited (“AECOM”) in accordance with its contract with Locality (the “Client”) and in accordance with generally accepted consultancy principles, the budget for fees and the terms of reference agreed between AECOM and the Client. Any information provided by third parties and referred to herein has not been checked or verified by AECOM, unless otherwise expressly stated in the document. AECOM shall have no liability to any third party that makes use of or relies upon this document.

CONTENT

01. Introduction	04	03. Design Guidance & Codes	12
01.1 Introduction	05	03.1 Strategic Design Guidelines & Codes	13
01.2 Objectives	05	03.2 Built Form	19
01.3 Process	05	03.3 Environment & Landscape	26
01.4 Area of Study	05	03.4 Sustainability & Energy Efficiency	31
01.5 Key Policy & Guidance	05	03.5 General questions to ask and issues to consider	36
02. Local Context Analysis	07	04. Delivery	41
02.1 Movement	08		
02.2 Landscape and Green Infrastructure	09		
02.3 History and Heritage	10		
02.4 Character Areas	11		

01

02

03

04

Introduction

01



01. Introduction

01.1. Introduction

Through the Ministry of Communities and Local Government (MHCLG) Neighbourhood Planning Programme led by Locality, AECOM has been commissioned to provide design support to Lawshall Neighbourhood Plan Steering Group.

This document provides design expectations that need be taken into account should any development proposals come forward in the area. This document supports Neighbourhood Plan policies that aim to help maintain Lawshall's distinct rural character.

01.2. Objectives

The primary objective of this report is to develop design guidelines and codes that future development within Lawshall should follow to retain and protect the rural, tranquil character and scenic beauty of the area.

01.3. Process

Following an inception meeting with the Lawshall Parish Council representatives and a virtual site visit, AECOM carried out a high level assessment of the area. The following steps were agreed to produce this report:

- Initial meeting and virtual site visit;
- Urban design analysis;
- Preparation of design principles and codes to be used to assess future developments;
- Draft report with design guidelines and codes; and
- Final report.

01.4. The Area of Study

Lawshall is a working agricultural village located in western Suffolk. The village lies 7 miles south of Bury St Edmunds and north of Sudbury off the A134. The village has a population of 968 as of the 2011 Census and consists of a unique string of hamlets with their own greens and separated by rolling farmland. There are a high number of working farms in the village with many farm buildings interspersed with residential dwellings.

The more recent development has taken place within the central hub of the village which is located around a triangle of roads. This main built up area is home to around 45% of the village population. The area boasts rich and varied wildlife supported by the many greens, private habitat conservation areas, a community woodland and an extensive network of ancient hedgerows.

01.5. Key Policy & Guidance

There are a few key local planning policies and guidance documents that have been referred to closely in the development of this document, including:

- The existing Lawshall Neighbourhood Plan (2017)
- Lawshall Character Assessment (2016)
- Draft Babergh and Mid Suffolk Joint Local Plan (2020)

The new National Model Design Code (2021) has also been used to guide the development of this document to understand the key characteristics of Lawshall and how they can be used to create design codes that are relevant to the context of the village.



Figure 1: Map showing the location of Lawshall in the wider area.



Figure 2: Map showing the Neighbourhood Plan Area Boundary.

Local Context
Analysis

02



02. Local Context Analysis

Introduction

This chapter describes the local context and key characteristics of Lawshall including movement, heritage, landscape and green infrastructure as well as the character areas described in the Lawshall Neighbourhood Plan Character Assessment.

02.1. Movement

Lawshall is made up of a string of hamlets linked by three neighbourhood roads that meet in the central triangle. Much of the village's dwellings are located along these roads with a few cul-de-sacs forking off. The main road to the east of Lawshall is the A134 which goes north to Bury St Edmunds and south towards Sudbury.

There are a number of bus stops along Harrow Green, however the bus service only runs a couple of times a week. There are a number of Public Rights of Way that surround the Neighbourhood Plan area but only one that runs north to south through the eastern part of the village, meaning there are few links to the countryside from the village.

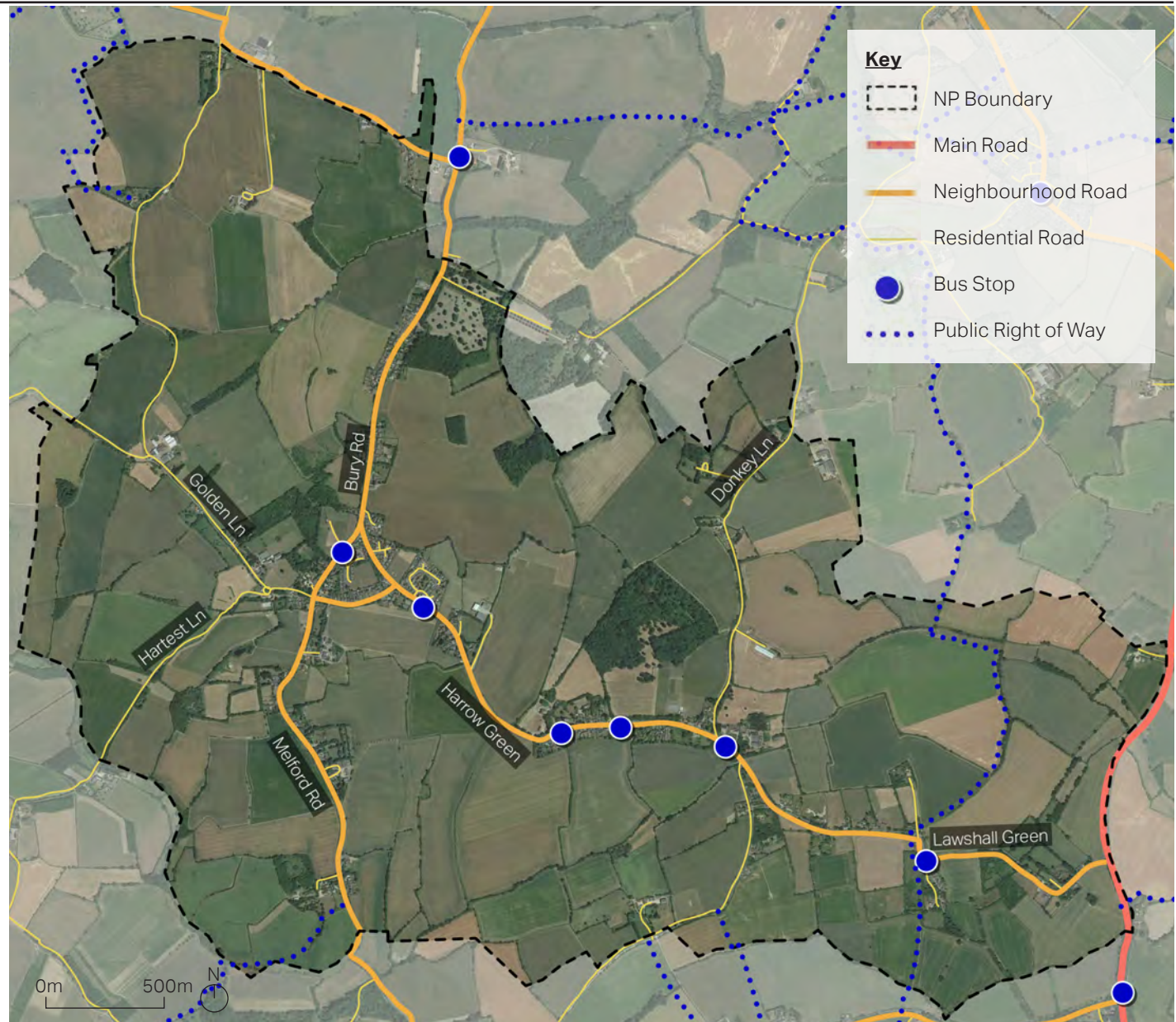

Figure 3: Patterns of access and movement in Lawshall.

02.2. Landscape & Green Infrastructure

Lawshall is a working agricultural village with a string of hamlets separated by rolling farmland. Being surrounded by plenty of open land and farmland means there are many important views looking out over the open space from different points in the village.

There is an area of local landscape sensitivity which needs to be carefully considered so there are no adverse effects on the area. Frithy Wood, situated within the area of local landscape sensitivity, is also an SSSI and is designated as an important woodland. Other important woodland includes the community woodland project of 23 acres which is planted and managed by the community. There is an extensive network of ancient hedgerows that provide habitat to many species of plants and animals and contribute to the rich biodiversity of the area.

There are many greens within the village spread across the different hamlets which are designated as important recreation and green space. The central green space in the triangle is also used as an informal playing field. The adjacent green space has a fenced play area but is the only children's play area within the village. There is one other playing field which is used as a cricket pitch and football ground.



Figure 4: Landscape designations and green infrastructure in Lawshall.

02.3. History and Heritage

The village has a long history, although it is not known where the original settlement stood. The All Saints Church dates back to the 15th Century and is the only Grade I Listed Building in the village and has architectural, historical and topographical value. There is one Grade II* Listed Building within the village, Lawshall Hall, which is adjacent to All Saints Church. The original manor house on the site of Lawshall Hall dated back to the 11th Century, however it was rebuilt in 1557 as a red brick house, which still stands today with many alterations throughout time. There is an important historical connection as Queen Elizabeth I visited Lawshall Hall during her Royal Progress tour in 1578.

There are many Grade II Listed Buildings within the village with a distinct cluster near the All Saints Church. Other listed buildings are scattered around the village. There is also a Scheduled Monument, a moated site immediately south east of New House Farm, to the south of the Neighbourhood Plan area.



Figure 5: Map showing Lawshall's heritage assets.

02.4. Character Areas

The character areas shown here are taken from the Character Assessment in support of the 2017 Neighbourhood Plan, undertaken by the Neighbourhood Planning Group. The parish has been divided into four types of character areas.

The first is the main population hub which is characterised by 20th century development and is more highly populated than the outlying hamlets. This area has a number of greens with houses that generally have their back to the green spaces. An exception to this are the houses surrounding the Glebe which look out over the green space. There are also some cul-de-sacs.

The Residential Roads character areas consist of three long, fairly straight roads with ribbon development forming small clusters of housing. The buildings range in age and architectural style from attractive listed properties to Victorian terraces and infill development. They are generally low density with generous, well landscaped gardens. Large gaps between clusters allow for views to the open countryside.

The Village Greens character areas comprise four small hamlets separated by farmland. Their greens are all managed for wild flowers and conservation. Residential properties are interspersed with working farms and farm buildings. Panoramic views are an important feature of the rural setting, wildlife and dark night skies.

The Country Lanes character areas are the most rural and least populated parts of the village. The winding lanes are often only a single lane in width and the housing density is low with clusters of no more than four or five dwellings. The lanes maintain the feel of traditional countryside and are rich with wildlife. There is little scope for development in these locations and they are quite far from the village amenities.

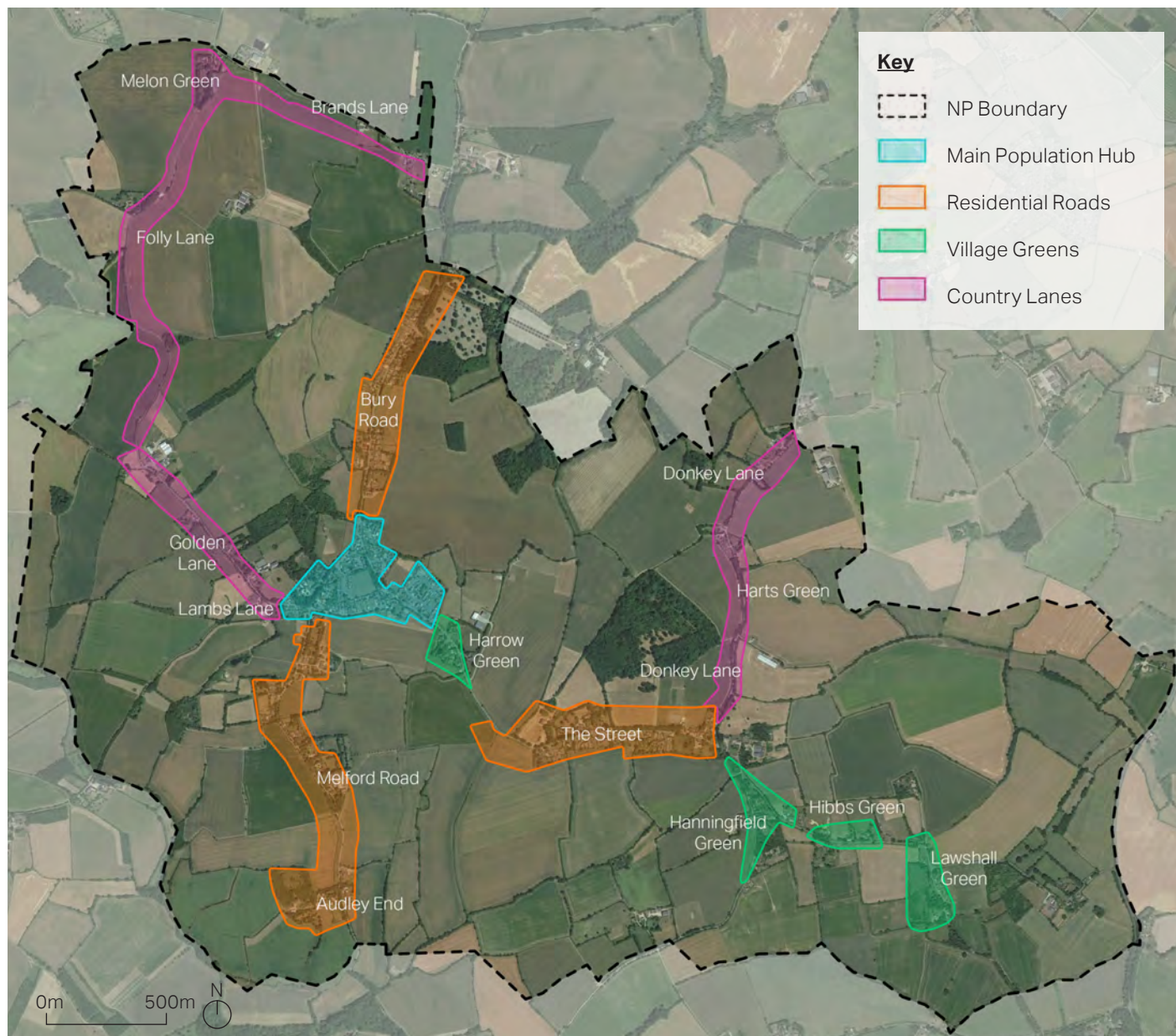

Figure 6: Character areas within Lawshall.

Design
Guidance &
Codes

03



03. Design Guidelines & Codes

Introduction

This chapter presents specific design guidelines and codes to ensure that future development within Lawshall follows good design principles, is of high-quality and reflects the existing local character and context of the village and surrounding countryside.

- While cul-de-sacs are a characteristic of the village, new development should seek to enhance and create permeability, particularly for pedestrians and cyclists.

03.1. Strategic Design Guidance & Codes

SD1. PATTERN OF DEVELOPMENT & LAYOUT

The layout of Lawshall has developed over time and consists of three types of building arrangements. Much of the historic development forms a ribbon development with a linear road and dwellings on either side, with a view to the countryside at the rear and often from the front of the building as well. The main population hub, which generally consists of newer development has dwellings arranged around a central green village green. This area also has some cul-de-sacs which fork off from the main road.

- The existing ribbon development forms clusters along one or both sides of the road, each with their own green, and are separated by gaps along the road often with important views to the surrounding countryside. New development should avoid filling in the gaps in-between existing development in order to preserve the character and views of the ribbon development.
- Development within an area should have the buildings orientated so the primary frontage faces the street and have access directly from the street. In the village green character areas, the development should also overlook the central green space.
- For all areas, particularly where there are cul-de-sacs, high rear fences and walls adjacent to the street should be avoided.



Figure 7: Plans showing different development typologies.

SD2. ENCLOSURE

Enclosure is the relationship between public spaces and the buildings or other features that surround them. A more cohesive and attractive urban form is achieved where this relationship is in proportion. The following guidance should be considered to achieve a satisfactory sense of enclosure.

- Façades should have an appropriate ratio between the width of the street and the building height.
- Buildings should be designed to turn corners and terminate in views.
- Narrow gaps between buildings must be avoided, they should be either detached, semi-detached or properly linked.
- Building lines should run parallel to the back of the pavement.
- A variety of plot widths are recommended for clusters of dwellings and facade alignments should be considered during the design process to create an attractive villagescape.

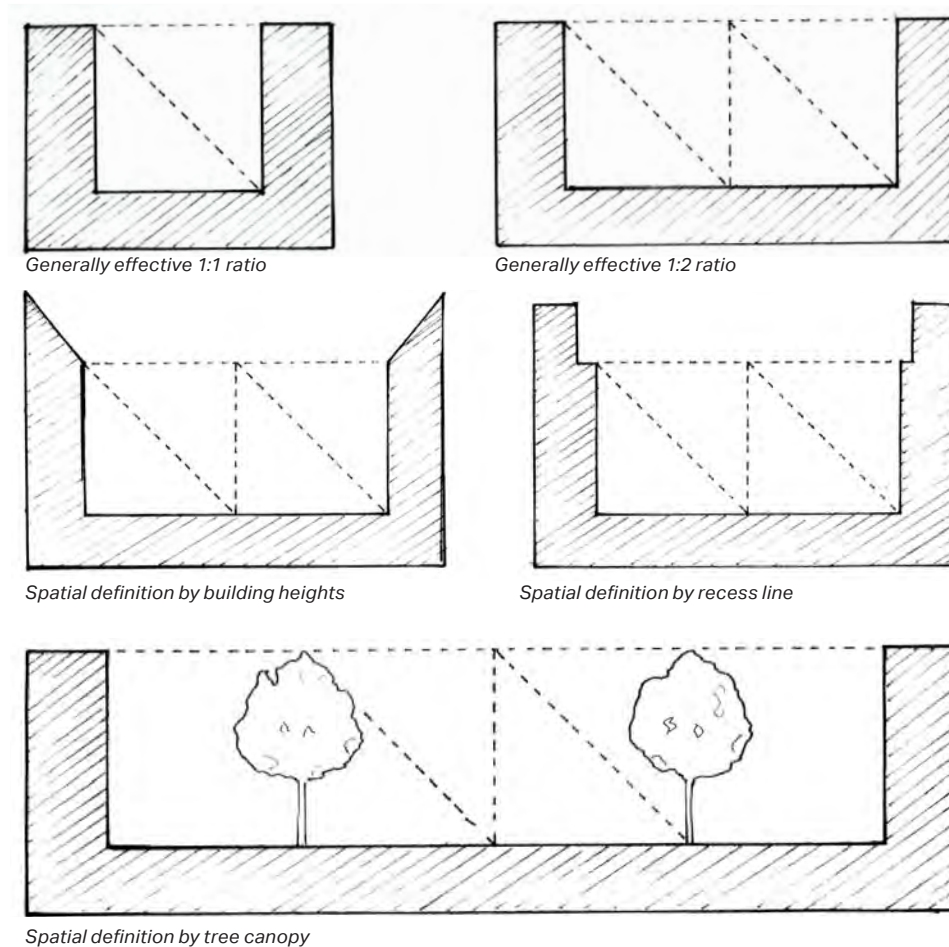

Figure 8: Diagrams showing enclosure ratios.

SD3. OVERLOOK PUBLIC SPACE

Village greens are a common feature within Lawshall and are generally arranged so that dwellings look out over the green space to allow for natural surveillance. An exception to this can be seen in the main population hub where fences back onto the central green space, however this arrangement should be avoided in the future.

- Buildings should have openings such as doors and windows that look out over the street and public spaces. This provides eyes on the street, acting as natural surveillance to enhance the perception of safety along the street and within public spaces.

SD4. TURN THE CORNER

Buildings located on the corner of two street plays an important role for natural surveillance and for wayfinding.

- Corner buildings enhance the natural surveillance of the street by providing two primary street facing façades that have openings that look out over the street.
- Corner buildings should have active frontages on all street facing façades. This means having windows of habitable rooms on all façades that face the street.
- Corner buildings can be articulated with a taller or distinctive architectural element to enhance legibility and wayfinding.



Figure 9: Diagram showing buildings fronting onto public space and corner buildings.

SD5. FRONTS & BACKS

The majority of the village forms a ribbon development with well-defined frontages facing the street and defined backs with rear fences backing onto the open countryside.

- Any new development should have well-defined fronts and backs in order to maintain the structure of the village.

SD6. MAINTAIN A CONSISTENT BUILDING LINE

The location and orientation of the buildings in relation to the street can affect the feel of an area.

- The building line along a street should generally be consistent and form a unified whole but allow for subtle variations in the form of recesses and protrusions. This provides variety and movement along the street.
- Boundary treatments should reinforce the sense of continuity of the building line and help define the street, appropriate for the character of the village.

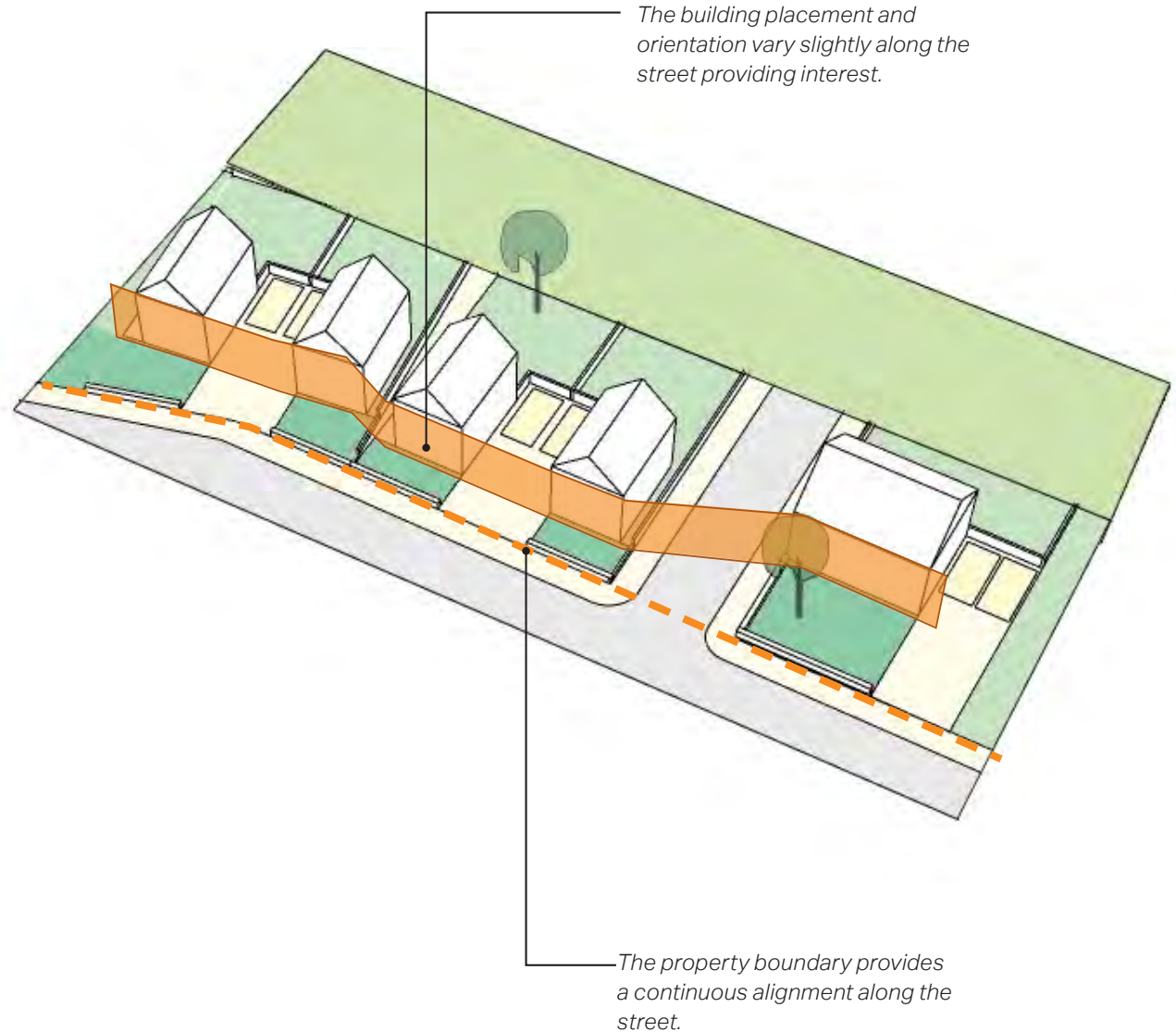

Figure 10: Diagram showing fronts, backs and consistent building lines.

SD7. SIGNAGE & WAYFINDING

Signage and wayfinding techniques are an integral part of encouraging sustainable modes of transport as they make walking and cycling easier by ensuring that routes are direct and memorable.

- Places should be created with a clear identity and be easy to navigate.
- Local landmark buildings or distinct building features such as towers or chimneys can aid legibility. Landscape features, distinctive trees and open spaces can also be used as wayfinding aids as well as providing an attractive streetscape.
- Clear signage should be placed at key nodes and arrival points to aid orientation.

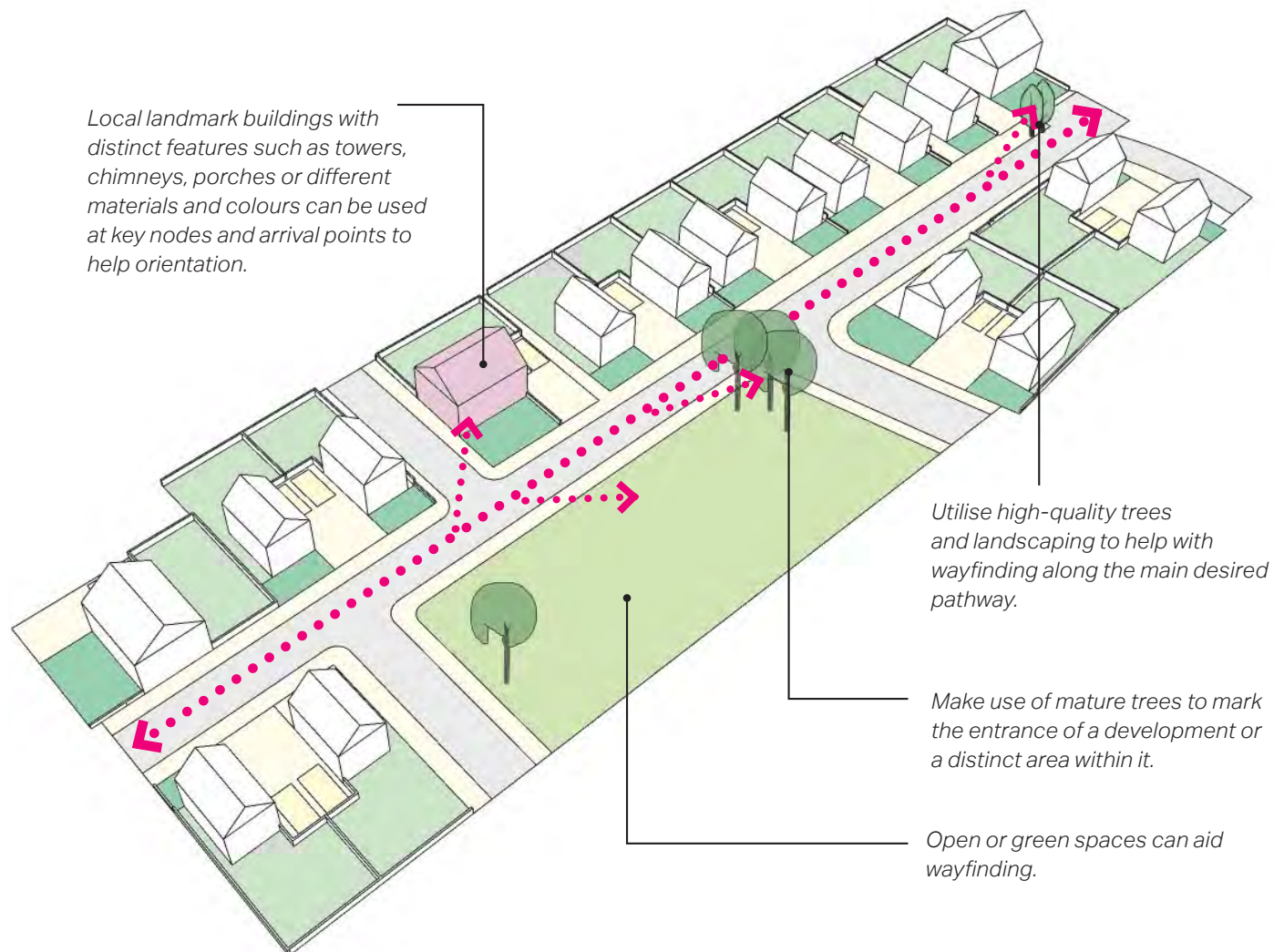

Figure 11: Diagram showing different wayfinding elements along the street.

SD8. IMPORTANT VIEWS

The landscape which surrounds Lawshall plays an important role in providing a rural setting, particularly in distant views. There are a number of important views to the countryside from the village, including panoramic views from the Village Green character areas and views from the gaps in the settlement.

Proposals must consider the effects upon views, landmarks, topography and natural features of the new development, to protect and enhance any significant views. Proposals should also identify potentially relevant new views, for example, if the site has a vantage point over the surrounding landscape.

- Development must identify surrounding key views, assess its visual impact and consider its effects on both the surrounding landscape points and neighbouring communities and settlements.
- Development must identify whether the new dwellings will be visible on the skyline in distant views and if so, what its impact will be particularly in relation to the roofscape of existing buildings. Proposals for new developments must not dominate or distract from key views.
- Proposals must not obstruct any established view. Loss of views from within the village to the wider landscape beyond should be preserved and where possible enhanced.



Figure 12: Important panoramic view from the Village Green character area.



Figure 13: Important view from the road in between the settlements of Lawshall.

03.2. Built Form

The built form focuses on the relationship between the buildings and the streets as this contributes to the character of a place. In Lawshall, different parts of the village vary in character, however there are some overarching design elements that make the village cohesive while still allowing for subtle variation.

BF1. HERITAGE

Due to Lawshall's long history, there are various heritage assets within the village that are essential to its character, therefore these features must be respected. Designated heritage assets include one Grade I Listed church, many Grade II Listed Buildings, Grade II* Listed Lawshall Hall and a Scheduled Monument.

- Development which could lead to harm of any designated and non-designated heritage asset must respect the significance of the asset and must demonstrate how local distinctiveness is reinforced.
- Development should respect the heritage asset's surroundings, paying particular consideration to maintaining their role in framing, punctuating or terminating key views through, out of and into the village.
- Consideration should be given to the retention of open spaces and gaps between buildings to sustain the historic form and pattern of development and the setting of the heritage asset.



Figure 14: All Saints Church, Grade I Listed Building.



Figure 15: The Howes, Grade II Listed Building.



Figure 16: Post office, Grade II Listed Building.

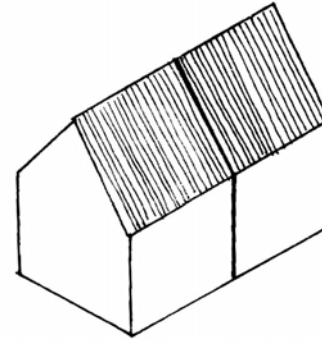

Figure 17: The Cottage and Harts Green Cottage, Grade II Listed Building.

BF2. SCALE, FORM & MASSING

The scale, form and massing of buildings can alter the experience of a street, therefore can have a big impact on the identity and character of a place. The existing built context can guide new development to preserve and enhance the best features of Lawshall, ensuring a harmonious relationship with neighbouring buildings, spaces and streets. Furthermore, new development should react sensitively to the existing environment, especially in more rural areas of the village.

- New development should take into consideration the building typologies of the character area that it is located within. For example, the main population hub has the greatest variety of building typologies including detached, semi-detached, terrace and bungalows. Other areas of the village have more detached and semi-detached properties.
- Throughout Lawshall the buildings range in height from 1 to 2.5 storeys. New development should respect the existing building heights of the neighbouring buildings to ensure the character of the particular street is not negatively affected. For example, Churchill Close within the main population hub, consists of bungalows, therefore it would be inappropriate for a building to be more than 1 storey in height as it would alter the character of the street.
- The shape of buildings vary throughout the village, however most are a simple form with some protrusions and added detailing.



Attached dwellings

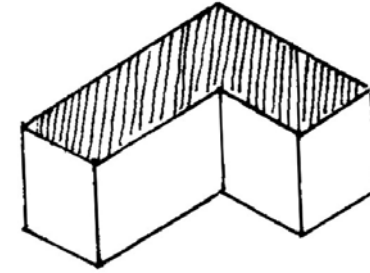

L-shaped dwelling

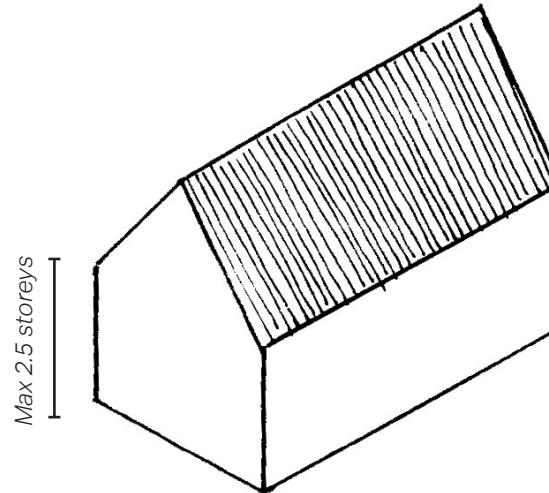

Individual dwelling

Figure 18: Diagram showing building form and building heights.

BF3. ESTABLISH A CONSISTENT PROPERTY BOUNDARY

- A consistent property boundary helps create harmony and cohesion along the street.
- Boundary treatments should be used at the plot edge to provide continuity along the street and provide separation between the public and private domain.
- The materials used along the boundary edge can bring cohesion to the street and the village, whilst still providing visual interest using a range of high-quality materials such as brick walls or hedgerows. The materials used should complement the existing boundary treatments along the street, particularly those on adjoining plots.
- The boundary treatment should be a maximum of 1.2m in height.
- Properties should also have a front garden which can range from 3-6m in depth to create the desired amount of enclosure along the street.

BF4. GROUND APPEARANCE

- The ground appearance within the curtilage of the property boundary should be finished using high-quality materials that compliment the building materials and colours.
- Front gardens should use mostly grass, plants and other natural elements. Paving over the front garden should be avoided where possible.
- Driveways should use permeable paving to enable water to filter through to avoid water running off to the highway and should be in harmony with the landscaping surrounding the property (see SE5. Permeable pavements, p34).

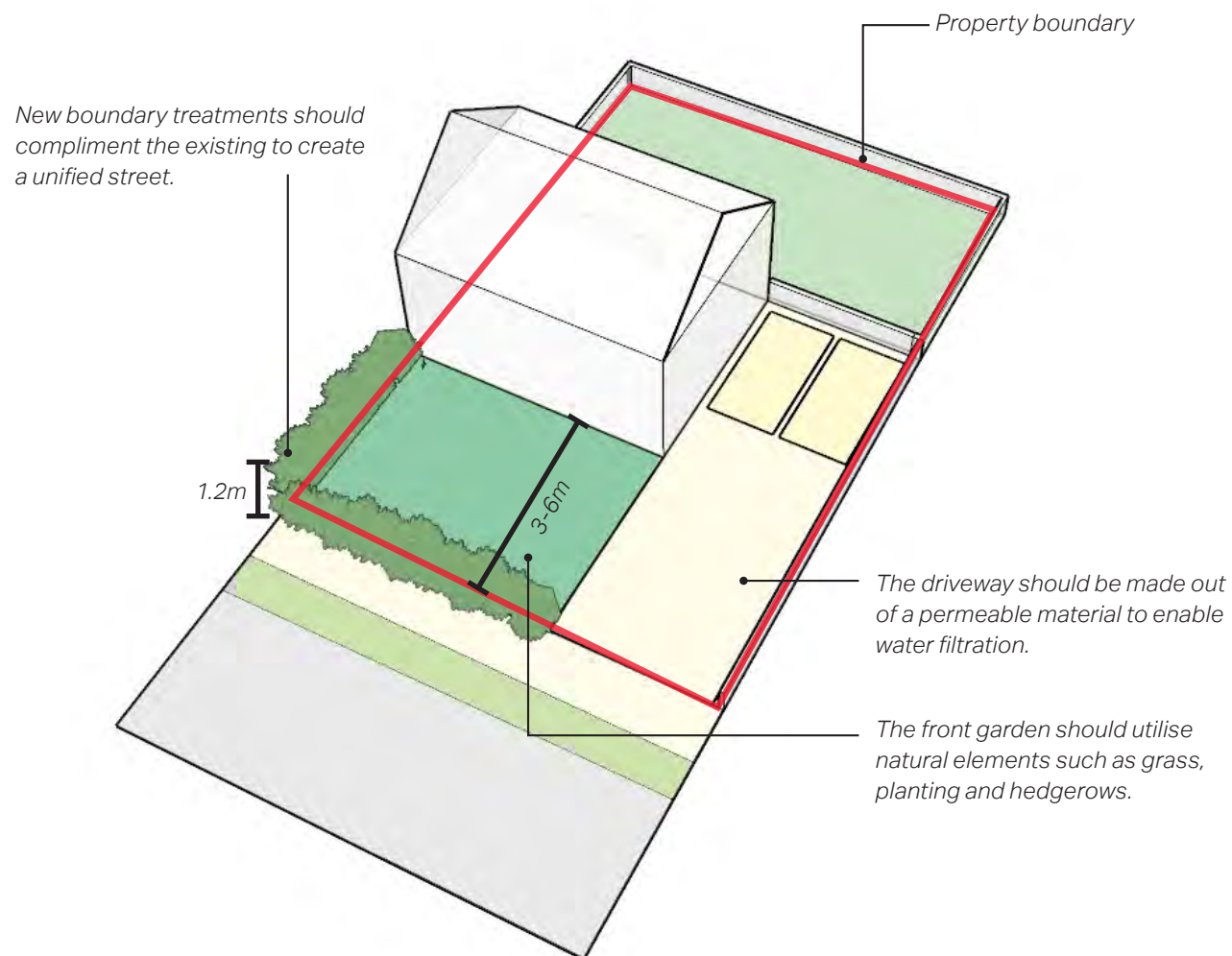

Figure 19: Diagram showing the property boundary treatment and front garden.

BF5. ROOF PROFILE

- Creating a good variety in the roof line helps make a place attractive.
- The scale of the roof should always be in proportion with the dimensions of the building.
- Monotonous building elevations should be avoided, with subtle changes in the roof line being promoted during the design process.
- There are a range of roof types in Lawshall with the most common being pitched or cross gabled roofs as well as some hipped roofs.
- Local traditional roof detailing elements should be considered and implemented where possible.
- Roofs should also be designed with photovoltaic taken into consideration, either as part of the initial design or for future retrofit. The orientation and available roof space should also be considered.

BF6. FAÇADES & FENESTRATION

- The street facing façades of a building should have openings such as doors and windows that are arranged in an orderly way to create a sense of rhythm along the street.
- Bay windows and dormers can be used to articulate the building elevation but must be appropriately sized and well-integrated through their materiality and positioning.



Figure 20: Varied roof line along Bury Road at the northern edge of the Main Population Hub.



Figure 21: Pitched and gable ended roof within the Main Population Hub character area.



Figure 22: Traditional thatched roof building.

BF7. ARCHITECTURAL DETAILING

Any new development will need to look at the scale, height, style and detailing of the surrounding buildings to ensure it respects the existing village character. Lawshall's character is greatly enhanced by highly valued features that have been built using traditional techniques and locally sourced materials. The following architectural considerations should be taken into account throughout the design process:

DORMERS

- Dormer windows should be kept at an appropriate scale and should not dominate the roof. They should be aligned with the building's windows below or centred in the middle.

CHIMNEYS

- Chimneys are generally found on the more historic buildings within the village, however they can add articulation and rhythm to more modern buildings.

MATERIALS & COLOUR PALETTE

- Some of the traditional materials that can be seen in the village include oak, timbers, flints, clay, thatching and lime plaster. The village has some good examples of traditional materials and techniques being adapted to suit new dwellings such as Pantiles (curved tiles).
- In the past, neutral lime wash would probably have been the most prominent colour for rendered dwellings due to it being the cheapest, however today a variety of colours can be seen throughout the village including Suffolk pink as well as different shades of ochre and terracotta.



Figure 23: Dwelling with pantile roof tiles.



Figure 24: Dormer windows and light yellow rendering.



Figure 25: Example of a modern building in Lawshall.



Figure 26: Chimney detailing.

BF8. EXTENSIONS

Extensions to dwellings can have a significant impact not only on the character and appearance of the building, but also on the streetscene within which it sits.

A well-designed extension can enhance the appearance of its street, whereas an unsympathetic extension can have a harmful impact, create problems for neighbouring residents and affect the overall character of the area.

- Extensions must be appropriate to the scale, massing and design of the main building and should complement both the streetscape and the rural setting.
- Alterations and extensions of historic buildings should conserve or enhance their character.
- Extensions are more likely to be successful if they do not exceed the height of the original or adjacent buildings. Two-storey extensions, where appropriate, should be constructed with a pitch sympathetic to that of the existing roof.
- The design, materials and architectural detailing of extensions should be high-quality and respond to the host building and the local character of the village.
- The impact on the space around the building should avoid overlooking, overshadowing or overbearing.

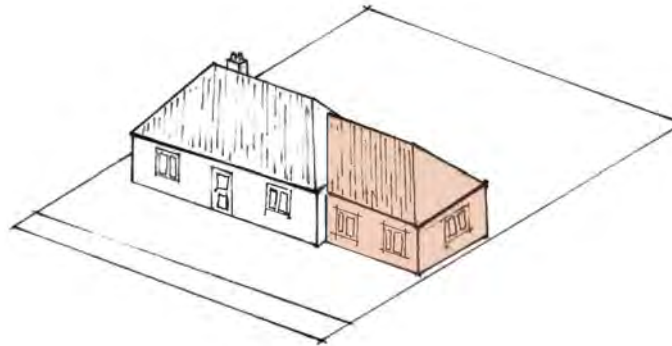

Single-storey side extension



Double-storey side extension

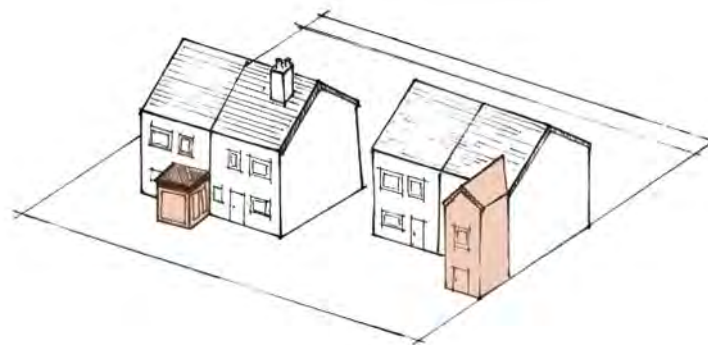

Single and double storey rear extension

Figure 27: Diagram showing the different types of extensions.

BF9. ADAPTABILITY

Houses should be designed to meet the differing and changing needs of households and people's physical abilities over their entire lifetime. One way to achieve this is to incorporate all the standards- M4(1), M4(2) and M4(3)- of the approved document M4 of the Building Regulations in the design of new homes and to assess whether they can be retrofitted in existing properties.

The diagram to the right illustrates the principles of inclusivity, accessibility, adaptability and sustainability in a dwelling.

**It should be noted that Neighbourhood Plans are limited when it comes to additional requirements such as space and energy efficiency for new dwellings, (written Ministerial Statement, Eric Pickles, 2015), however this page aims to demonstrate best practice design that should be taken into consideration.*

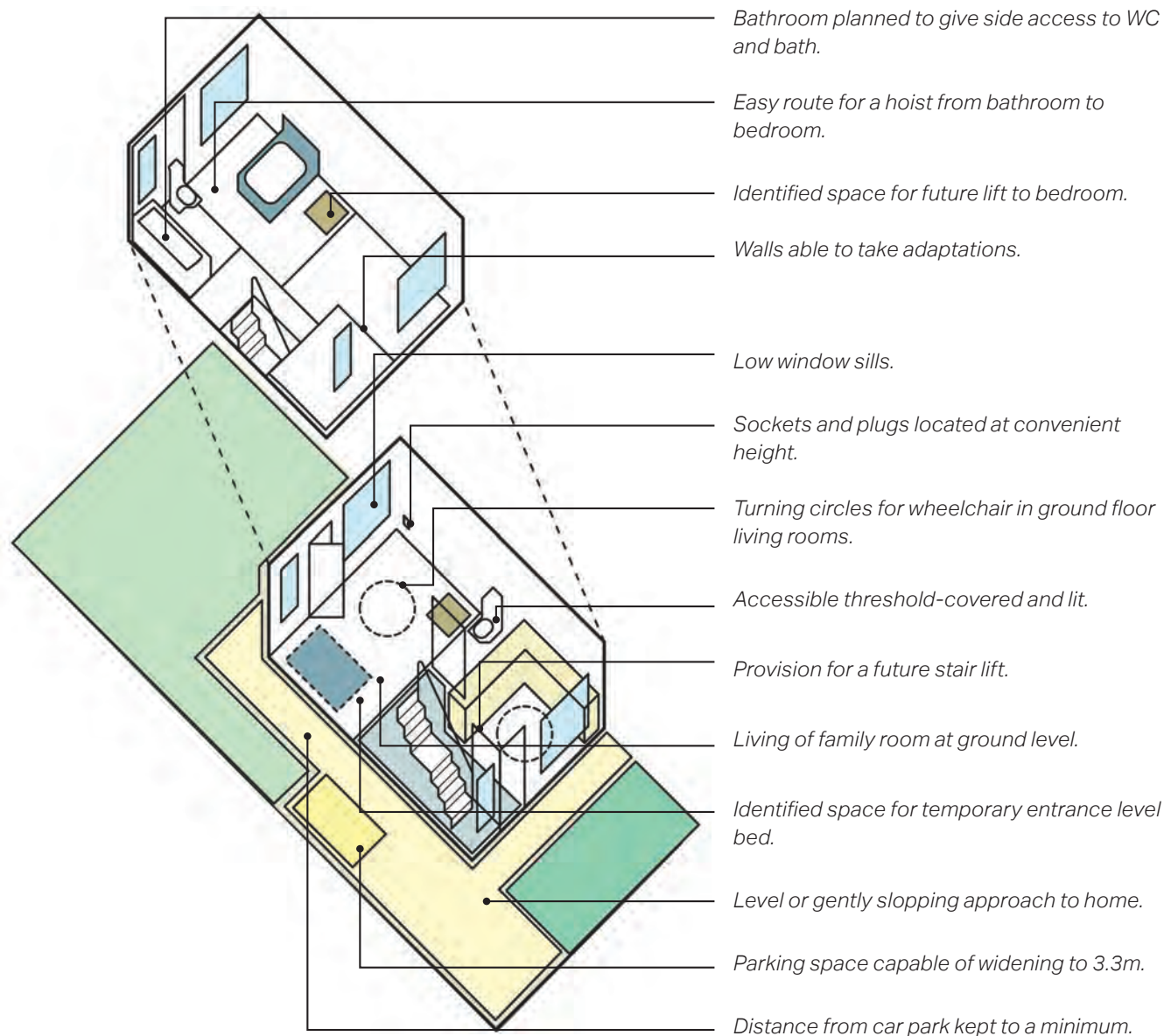

Figure 28: Diagram demonstrating design considerations for a lifetime home.

03.3. Environment & Landscape

Given Lawshall's location surrounded by countryside and farmland, preserving and enhancing the natural landscape will provide many benefits for the physical and mental health of humans as well as allowing natural habitats and biodiversity to thrive. Due to the importance of open and green spaces they should be considered integral to any development and be considered at the beginning and throughout the design process.

EN1. NETWORK OF GREEN SPACES

Green networks, corridors and linkages are a key mechanism for reducing the adverse effects on the fragmentation of biodiversity. Within the village there are many front and back gardens and village greens as well as the surrounding countryside that all contribute to the current network of green spaces.

- Green and networks can be created by providing a series of both public and private green spaces including generous and vegetated front and back gardens, public green spaces, fields, and natural open spaces.
- Back to back gardens ensure a continuous wildlife corridor.
- Existing playing fields and children's play areas should be enhanced and new ones can be introduced at strategic locations connecting the public open spaces.
- New green pedestrian and cycle links can be integrated into the green network to connect new developments to the countryside and to open spaces within the village.

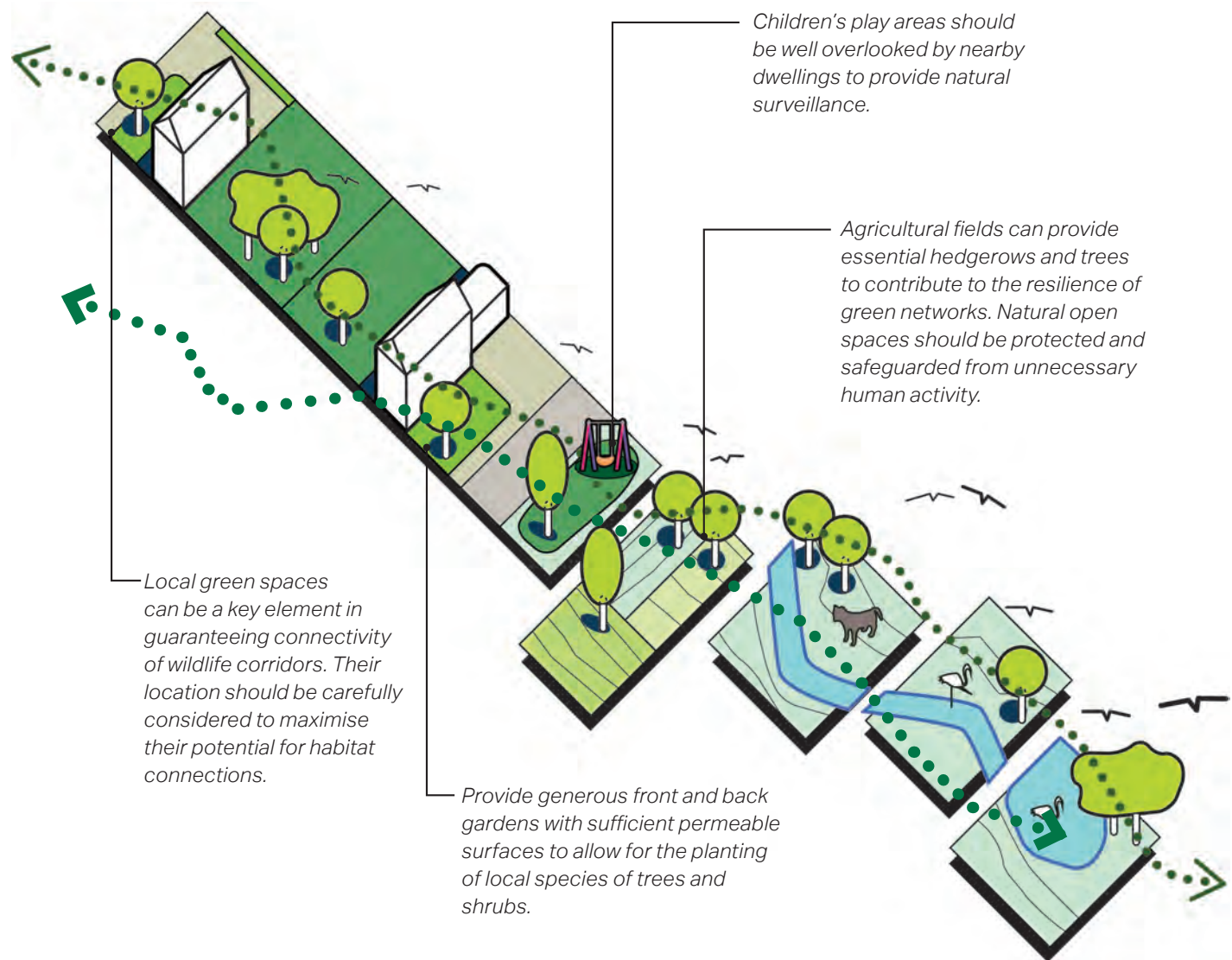

Figure 29: Diagram demonstrating a green network.

EN2. SuDS

Sustainable Drainage Systems cover a range of approaches to managing surface water in a more sustainable way, reducing flood risk and improving water quality as well as providing additional amenity benefits.

- Where reuse of water is not possible there are two alternative approaches using SuDS. The first is infiltration which allows water to percolate into the ground and eventually restore groundwater. The second is attenuation and controlled release. This holds back the water and slowly releases it into the sewer network. The overall volume entering the sewer system is the same, however the peak flow is reduced which reduces the risk of the sewers overflowing. Attenuation and controlled release options are suitable when either infiltration is not possible or where infiltration could be polluting.
- The most effective SuDS are site-specific and are integrated at the beginning of the design process.
- The SuDS components are further detailed in the Environment and Energy Efficiency section, however some of the key design elements and how they can work together have been shown in the diagram to the right.

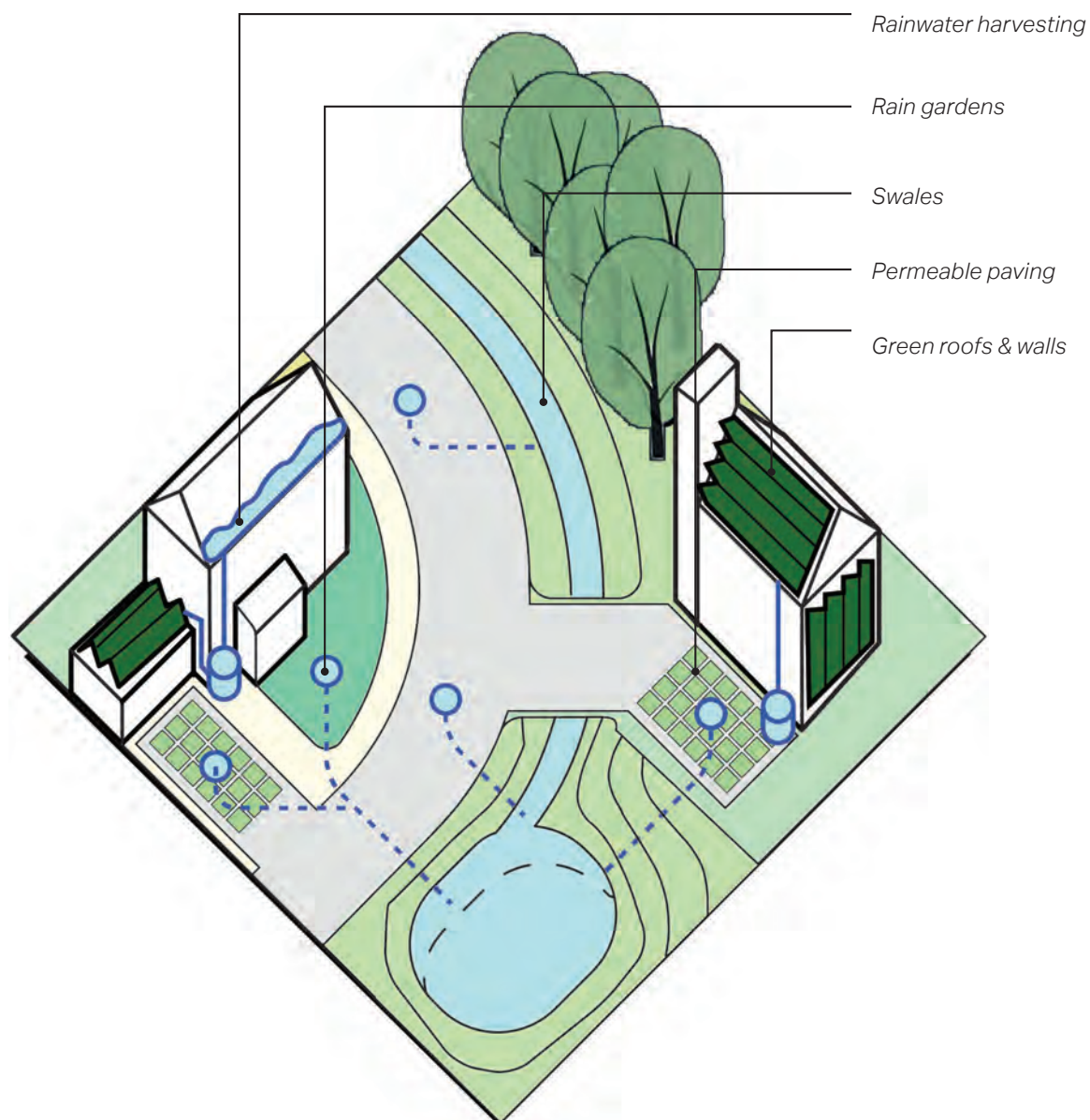

Figure 30: Diagram showing different SuDS elements.

EN3. STREET TREES & LANDSCAPING

Providing street trees and landscaping within the built environment creates an interesting and varied streetscape and brings physical and mental health benefits.

- Any existing mature trees should aim to be retained.
- New streets should be lined with trees to contribute to the character of the area and help mitigate the effects of climate change, as stated in NPPF, p39, para 131. Landmark trees can be used as feature elements and reference points for wayfinding. The species of trees used should be native to the area.
- Trees should also be present within public open spaces and children's play areas to create environmental and wildlife benefits.
- Where possible existing mature hedgerows should be retained. Hedges and other plantings such as flower beds are often used at the property edge to mark the private and public domain.



Figure 31: Diagram showing street trees and different types of planting.

EN4. BIODIVERSITY & WILDLIFE

Lawshall has a rich and varied landscape character with farmland, open countryside, and community woodland, as well as Scheduled Monuments.

There are a number of ways in which the built environment can support wildlife and even help it thrive. As well as design considerations there are a number of actions that can be taken by individuals and communities to foster wildlife and habitat creation.

BIODIVERSITY CORRIDORS

- Front and back gardens along with public green spaces and surrounding fields can play a key role in supporting wildlife. They have the potential to create habitat mosaics and enable wildlife corridors, often linked up with parks, tracks, rivers, churchyards and hedgerows.
- To support biodiversity corridors the use of chemicals in gardens should be reduced or eliminated.
- Plant early, mid-season and late blooming nectar rich flowers to attract pollinators and beneficial insects all year round.

HABITAT CREATION

- There are a number of ways to create local habitats for wildlife such as bee boxes, hedgehog homes, log and stone piles for invertebrates, toads and slow worms that will also inhabit compost heaps.
- Bird or bat boxes such as a hollow brick can be installed.

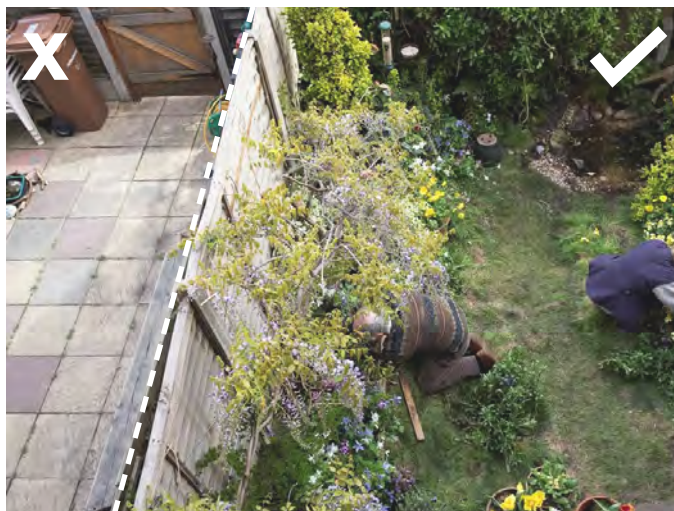

Figure 32: Right: paved back garden, left: biodiverse back garden.



Figure 34: Example of a bee box.



Figure 33: Bird box that can be used for nesting birds.



Figure 35: Small ponds can increase biodiversity.

EN5. LIGHTING & LIGHT POLLUTION

Street lighting is important for ensuring streets are safe for all that use them; however, it is important to get the right light, in the right place, at the right time of day in order to avoid unnecessary light pollution. Lighting schemes can be costly and difficult to change, therefore it is important the appropriate conditions are set out at the design stage.

- Any new development needs to ensure that lighting schemes will not cause unacceptable levels of light pollution, particularly in intrinsically dark areas, such as within the Village Greens character areas which have dark night skies.
- Lighting schemes that can be switched off when not needed should be considered.
- The needs of particular individuals or groups should be considered where appropriate (e.g. the safety of pedestrians, cyclists, drivers or older users).
- Vegetation and planting on front gardens should be dense to absorb light and offer some separation between public and private space.

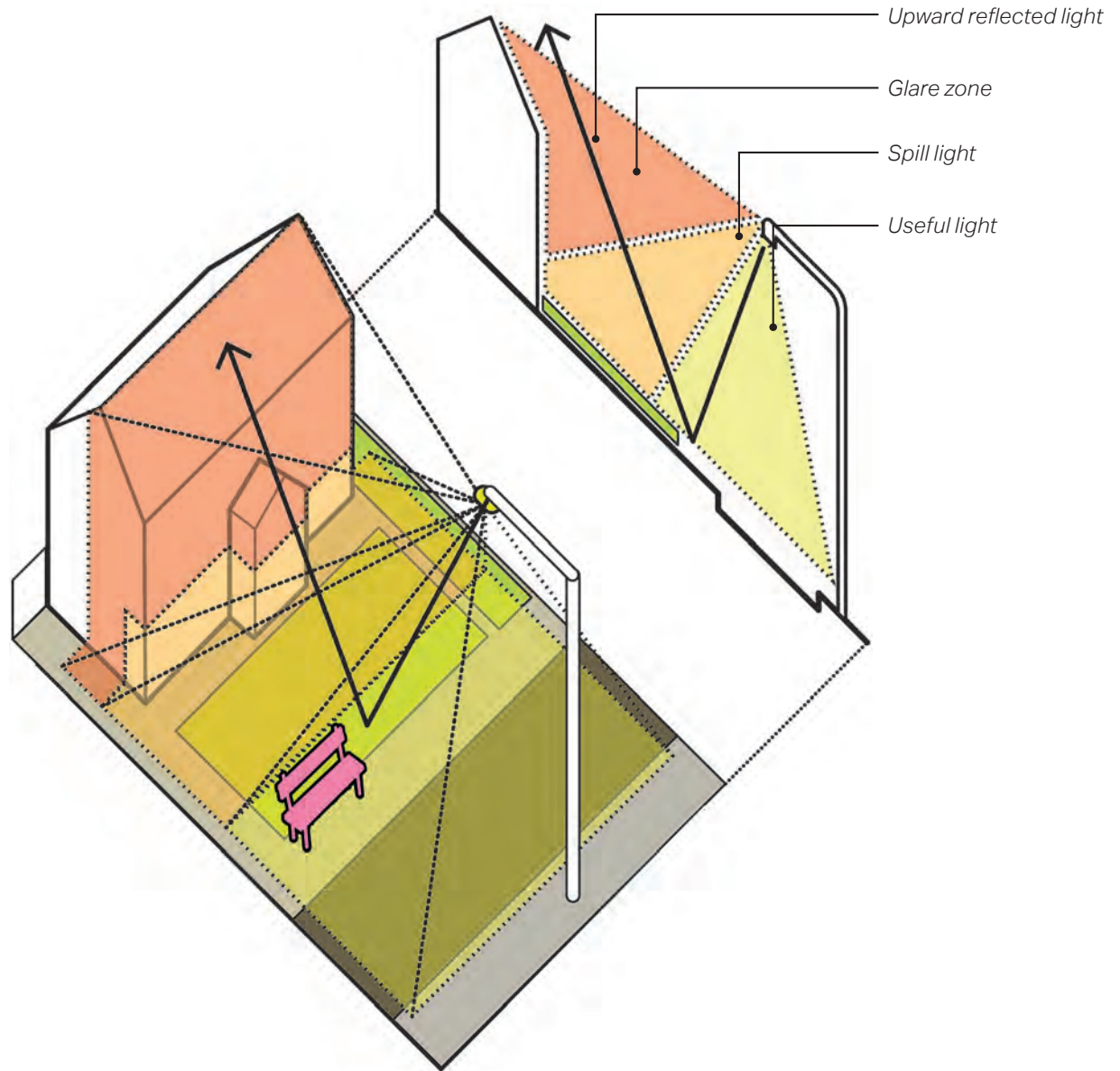

Figure 36: Diagram showing lighting and light pollution.

03.4. Sustainability & Energy Efficiency

This section introduces examples of energy efficient technologies and strategies that could be incorporated into new and existing buildings. Although these do not constitute a policy requirement, new development would be highly encouraged to embed these guidelines into their proposals.

NET-ZERO CARBON

The (draft) Local Plan states the ambition for Babergh and Mid Suffolk District to become carbon neutral by 2030. In order to achieve this target, all new development proposals, including refurbishment of existing properties, are required to minimise fossil fuel dependencies and should be able to demonstrate how the need to reduce carbon emission has influenced the design, layout and energy source used.

New developments should be built in such a way that, after taking account of emissions from space heating, ventilation, hot water and fixed lighting, expected energy use from appliances and exports and imports of energy from the development (and directly connected energy installations) to and from centralised energy networks, the building will have net zero carbon emissions over the course of a year.

- Buildings must be built with high levels of energy efficiency. Construction materials should be effectively reused, recycled and locally sourced. Material should be transported on site in the most sustainable manner and have low embodied energy.
- Buildings must achieve at least a minimum level of carbon reductions through a combination of energy efficiency, on-site energy supply and/or (where relevant) directly connected low carbon or renewable heat and choose from a range of (mainly off-site) solutions for tackling the remaining emissions.

SE1. BUILDING FABRIC

THERMAL MASS

Thermal mass describes the ability of a material to absorb, store and release heat energy. Thermal mass can be used to even out variations in internal and external conditions, absorbing heat as temperatures rise and releasing it as they fall. Thermal mass can be used to store high thermal loads by absorbing heat introduced by external conditions, such as solar radiation, or by internal sources such as appliances and lighting, to be released when conditions are cooler. This can be beneficial both during the summer and the winter.

Thermal storage in construction elements can be beneficial, such as a trombe wall placed in front of a south facing window or concrete floor slabs that will absorb solar radiation and then slowly re-release it into the enclosed space. Mass can be combined with suitable ventilation strategies.

INSULATION

Thermal insulation can be provided for any wall or roof the exterior of a building to prevent heat loss. Particular attention should be paid to heat bridges around corners and openings at the design stage.

Provide acoustic insulation to prevent the transmission of sound between active (i.e. living room) and passive spaces (i.e. bedroom). Provide fire insulation and electrical insulation to prevent the passage of fire between spaces or components and to contain and separate electrical conductors.

AIRTIGHTNESS

Airtight constructions help reduce heat loss, improving comfort and protecting the building fabric. Airtightness is achieved by sealing a building to reduce infiltration- which is

sometimes called uncontrolled ventilation. Simplicity is key for airtight design. The fewer junctions the simpler and more efficient the airtightness design will be.

An airtight layer should be formed in the floor, walls and roof. Doors, windows and roof lights to the adjacent walls or roof should be sealed. Link the interfaces between walls and floor and between walls and roof, including around the perimeter of any intermediate floor. Seal penetrations through the air barrier. Consider waster pipes and soil pipes, ventilation ducts, incoming water, gas, oil, electricity, data and district heating, chimneys and flues, including air supplies to wood burning stoves, connections to external services, such as entry phones, outside lights, external taps and sockets, security cameras and satellite dishes.

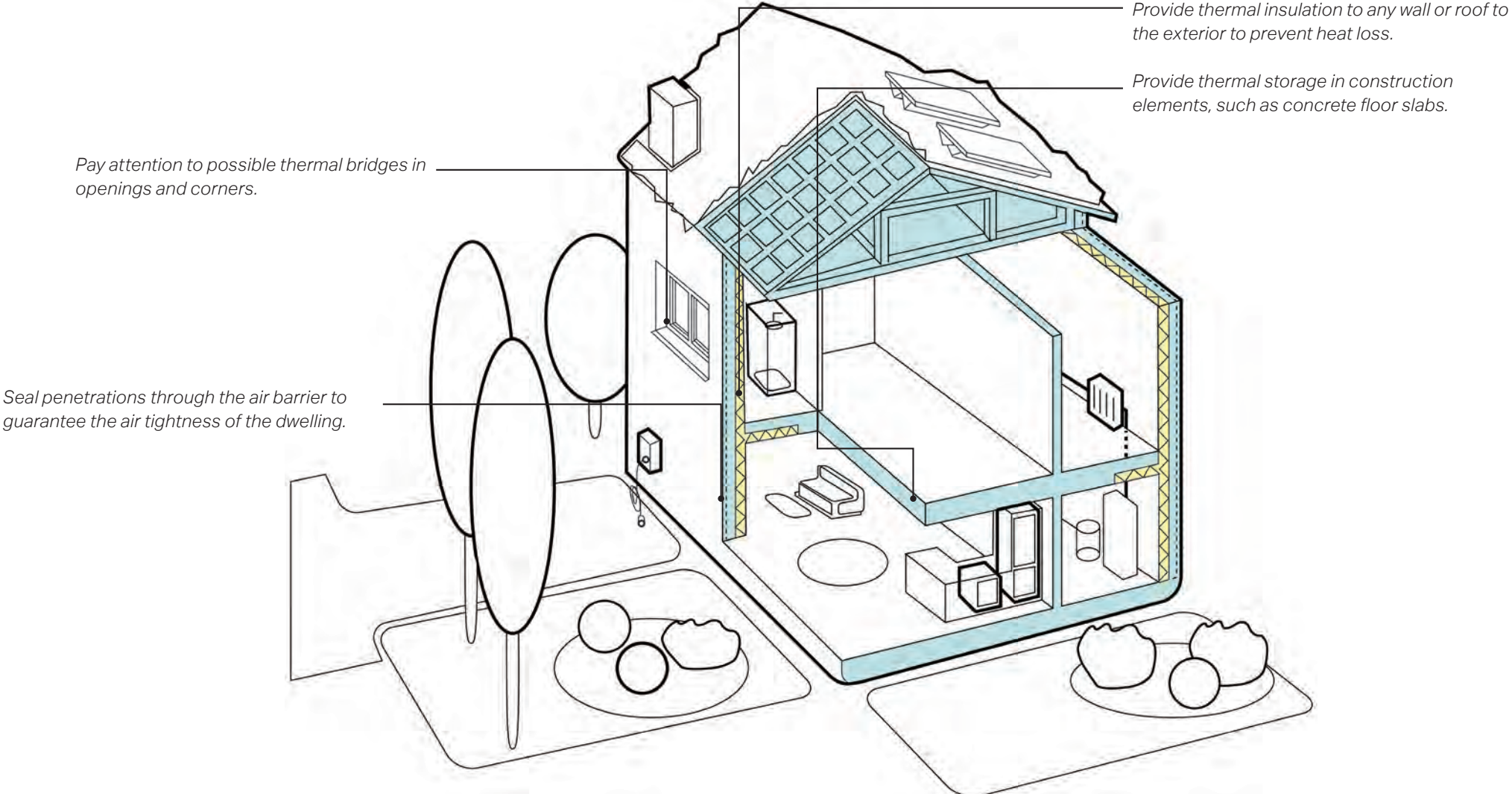

Figure 37: Diagram of a dwelling demonstrating the building fabric.

SE2. RAINWATER HARVESTING

Rainwater harvesting is a system for capturing and storing rainwater as well as enabling the reuse of in-situ grey water. Some design considerations include:

- Concealing tanks with complementary cladding.
- Use attractive materials or finishing for pipes, unsightly pipes should be avoided.
- Combine landscape or planters with water capture systems.
- Use underground tanks.



Figure 38: Water tank cladded with a complementary material.



Figure 40: Concealed tanks integrated with the design.

SE3. ROOF SOLAR PANELS

Solar panels should be designed to have a minimal visual impact on the roof of a building. New builds should incorporate solar panels from the beginning and form part of the design concept. Some attractive options are solar shingles, photovoltaic slates or tiles. Solar panels can also be used as a roofing material in their own right.

When retrofitting existing buildings the proportions of the roof and building should be considered to identify the best location and sizing of the panels. Tiles or slates of different colours can be added to the roof to better integrate the solar panels.



Figure 39: Retrofitted solar panels integrated sympathetically with a traditional building.



Figure 41: Solar panels integrated with a contemporary building design.

SE4. GREEN ROOFS AND WALLS

Green roofs can improve drainage and enhance biodiversity, as well as being an attractive option. Some design considerations are:

- To integrate the green roof into the design process.
- Easy to reach for maintenance.
- Should complement the surrounding landscape.

SE5. PERMEABLE PAVEMENTS

Permeable pavement should be used in front of properties along with front gardens to help with drainage and allow water to filter through. Some design considerations are:

- To respect the material palette of the building and the street.
- Harmonise with the landscape treatment of the property.
- Create an arrival statement and help define the property boundary.

SE6. CAR CHARGING POINTS

Electric car charging points should be included in new developments. Ideally, every house would have the provisions for an electric charging point. Within public spaces, electric charging points can be retrofitted to ensure easy and convenient access to encourage residents to switch to electric.



Figure 42: Housing extension with a green roof.



Figure 44: Garden building with a green roof.

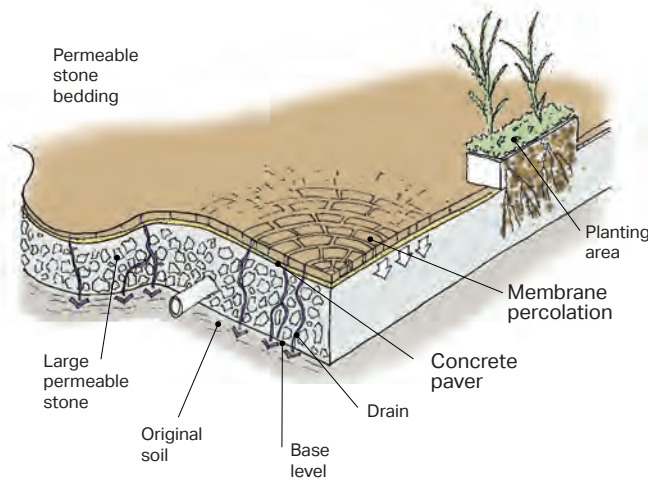

Figure 43: Diagram showing a section through permeable paving.



Figure 45: Public car charging point incorporated into the street design.

SE7. STORAGE

Storage can be provided for things such as bicycles, waste bins and deliveries that might otherwise clutter the streetscene.

CYCLE STORAGE

- Residential cycle storage should be provided within the property boundary. Dwellings with a garage can have combined cycle and waste storage within the garage. Dwellings without a garage should have a secure covered cycle enclosure.
- Ensure a sufficient level of security if the storage is accessible from the street.
- The design of the storage should be well-integrated and can be used as part of the property boundary.

WASTE STORAGE

- Specific enclosures of a sufficient size should be created for all the necessary bins. Bin storage can be used as part of the boundary treatment.
- Unattractive and unsafe rear alleyways between back garden fences must be avoided.

POST & DELIVERIES

- All dwellings should be provided with individual, lockable post boxes as well as a secure place to deposit parcel deliveries.
- Parcel boxes should be designed into the scheme from an early stage to avoid cluttering the streetscape. They must be placed discretely away from front elevations.



Figure 46: Residential cycle storage with a green roof.



Figure 48: High-quality materials used for the waste bin storage.



Figure 47: Waste bin storage used as a boundary treatment.



Figure 49: Example of a delivery box.

03.5. General questions to ask and issues to consider when presented with a development proposal

Because the design guidance and codes in this chapter cannot cover all design eventualities, this section provides a number of questions based on established good practice against which the design proposal should be evaluated. The aim is to assess all proposals by objectively answering the questions below. Not all the questions will apply to every development. The relevant ones, however, should provide an assessment as to whether the design proposal has taken into account the context and provided an adequate design solution.

As a first step, there are a number of ideas or principles that should be present in all proposals. These are listed under 'General design guidance for new development.' Following these ideas and principles, a number of questions are listed for more specific topics on the following pages.

1

General design guidelines for new development:

- Respect the existing settlement pattern in order to preserve the character. Coalescence - development should be avoided;
- Integrate with existing paths, streets, circulation networks;
- Reinforce or enhance the established character of streets, greens and other spaces;
- Harmonise and enhance the existing settlement in terms of physical form, architecture and land use;
- Retain and incorporate important existing features into the development;
- Respect surrounding buildings in terms of scale, roofline, height, form, and density;
- Enhance and reinforce the property boundary treatments;
- Adopt contextually appropriate materials and details;
- Provide adequate open space for the development in terms of both quantity and quality;
- Incorporate necessary services and drainage infrastructure without causing unacceptable harm to retained features;
- Ensure all components e.g. buildings, landscapes, access routes, parking and open spaces are well related to each other; and
- Aim for innovative design and eco-friendly buildings while respecting the architectural heritage and tradition of the area whilst also integrating them with future development.

2

Street grid and layout:

- Does it favour accessibility and connectivity over 1 cul-de-sac models? If not, why?
- Do the new points of access and street layout have regard for all users of the development; in particular pedestrians, cyclists and those with disabilities?
- What are the essential characteristics of the existing street pattern; are these reflected in the proposal?
- How will the new design or extension integrate with the existing street arrangement?
- Are the new points of access appropriate in terms of patterns of movement?
- Do the points of access conform to the statutory technical requirements?

3

Local green spaces, views and character:

- What are the particular characteristics of this area which have been taken into account in the design; i.e. what are the landscape qualities of the area?
- Does the proposal maintain or enhance any identified views or views in general?
- How does the proposal affect the trees on or adjacent to the site?
- Has the proposal been considered within its wider physical context?
- Has the impact on the landscape quality of the area been taken into account?
- In rural locations, has the impact of the development on the tranquillity of the area been fully considered?
- How does the proposal affect the character of a rural location?
- How does the proposal impact on existing views which are important to the area and how are these views incorporated in the design?
- How does the proposal impact on existing views which are important to the area and how are these views incorporated in the design?
- Can any new views be created?
- Is there adequate amenity space for the development?
- Does the new development respect and enhance existing amenity space?
- Have opportunities for enhancing existing amenity spaces been explored?
- Will any communal amenity space be created? If so, how this will be used by the new owners and how will it be managed?

4

Gateway and access features:

- What is the arrival point, how is it designed?
- Does the proposal maintain or enhance the existing gaps between settlements?
- Does the proposal affect or change the setting of a listed building or listed landscape?
- Is the landscaping to be hard or soft?

5

Buildings layout and grouping

- What are the typical groupings of buildings?
- How have the existing groupings been reflected in the proposal?
- Are proposed groups of buildings offering variety and texture to the townscape?
- What effect would the proposal have on the streetscape?
- Does the proposal maintain the character of dwelling clusters stemming from the main road?
- Does the proposal overlook any adjacent properties or gardens? How is this mitigated?

6

Building line and boundary treatment

- What are the characteristics of the building line?
- How has the building line been respected in the proposals?
- Has the appropriateness of the boundary treatments been considered in the context of the site?

Building heights and roofline

- What are the characteristics of the roofline?
- Have the proposals paid careful attention to height, form, massing and scale?
- If a higher than average building(s) is proposed, what would be the reason for making the development higher?

7

Household extensions

- Does the proposed design respect the character of the area and the immediate neighbourhood, and does it have an adverse impact on neighbouring properties in relation to privacy, overbearing or overshadowing impact?
- Is the roof form of the extension appropriate to the original dwelling (considering angle of pitch)?
- Do the proposed materials match those of the existing dwelling?
- In case of side extensions, does it retain important gaps within the street scene and avoid a 'terracing effect'?
- Are there any proposed dormer roof extensions set within the roof slope?
- Does the proposed extension respond to the existing pattern of window and door openings?
- Is the side extension set back from the front of the house?

8

Building materials and surface treatment

- What is the distinctive material in the area, if any?
- Does the proposed material harmonise with the local materials?
- Does the proposal use high-quality materials?
- Have the details of the windows, doors, eaves and roof been addressed in the context of the overall design?
- Does the new proposed materials respect or enhance the existing area or adversely change its character?

9

Car parking solutions

- What parking solutions have been considered?
- Are the car spaces located and arranged in a way that is not dominant or detrimental to the sense of place?
- Has planting been considered to soften the presence of cars?
- Does the proposed car parking compromise the amenity of adjoining properties?
- Have the needs of wheelchair users been considered?

10

Architectural details and design

- If the proposal is within a conservation area, how are the characteristics reflected in the design?
- Does the proposal harmonise with the adjacent properties?
- This means that it follows the height massing and general proportions of adjacent buildings and how it takes cues from materials and other physical characteristics.
- Does the proposal maintain or enhance the existing landscape features?
- Has the local architectural character and precedent been demonstrated in the proposals?
- If the proposal is a contemporary design, are the details and materials of a sufficiently high enough quality and does it relate specifically to the architectural characteristics and scale of the site?

Delivery

04



04. Delivery

This section concludes the document with recommendations on how it should be used in practice.

This document provides design guidance and codes for Lawshall based on an assessment of the existing built form and environmental components that characterise the Neighbourhood Plan area. This document is intended to facilitate future development in creating high quality places that respond to and complement the existing character and landscape setting of the village.

The design guidance and codes will be the mechanism by which the Neighbourhood Plan group can secure suitable, context driven development in the village. It will give certainty to both the local communities and developers and provide them with an understanding of what is expected of new developments. It is hoped that this certainty will bring benefits- both in terms of quality and timeliness required to progress development proposals through the planning system.

The different ways in which the design guidance and codes might be used by different stakeholders are set out in the table.

Actors	How They Will Use the Design Guidance and Codes
Applicants, developers, and landowners	As a guide to community and Local Planning Authority expectations on design, allowing a degree of certainty – they will be expected to follow the guidance and codes as planning consent is sought.
Local Planning Authority	As a reference point, embedded in policy, against which to assess planning applications. The Design Guidance and Codes should be discussed with applicants during any pre-application discussions.
Parish Council	As a guide when commenting on planning applications, ensuring that the Design Guidance and Codes are complied with.
Community organisations	As a tool to promote community-backed development and to inform comments on planning applications.
Statutory consultees	As a reference point when commenting on planning applications.

